



# OPERATING AND SERVICE MANUAL

## MODEL 333A/334A

### DISTORTION ANALYZER

Serial Numbers:

333A: 1137A03146 and greater

334A: 1140A05641 and greater

Appendix C, Manual Backdating Changes, adapts this manual to lower serial numbers.

#### **WARNING**

*To help minimize the possibility of electrical fire or shock hazards, do not expose this instrument to rain or excess moisture.*

Manual Part No. 00333-90008

Microfiche Part No. 00333-90058

Copyright Hewlett-Packard Company 1966  
P.O. Box 301, Loveland, Colorado, 80537 U.S.A.

HEWLETT  PACKARD

### CERTIFICATION

*Hewlett-Packard Company certifies that this instrument met its published specifications at the time of shipment from the factory. Hewlett-Packard Company further certifies that its calibration measurements are traceable to the United States National Bureau of Standards, to the extent allowed by the Bureau's calibration facility, and to the calibration facilities of other International Standards Organization members.*

### WARRANTY AND ASSISTANCE

This Hewlett-Packard product is warranted against defects in materials and workmanship for a period of one year from the date of shipment, except that in the case of certain components, if any, listed in Section I of this operating manual, the warranty shall be for the specified period. Hewlett-Packard will, at its option, repair or replace products which prove to be defective during the warranty period provided they are returned to Hewlett-Packard, and provided the proper preventive maintenance procedures as listed in this manual are followed. Repairs necessitated by misuse of the product are not covered by this warranty. **NO OTHER WARRANTIES ARE EXPRESSED OR IMPLIED, INCLUDING BUT NOT LIMITED TO THE IMPLIED WARRANTIES OF MERCHANTABILITY AND FITNESS FOR A PARTICULAR PURPOSE. HEWLETT-PACKARD IS NOT LIABLE FOR CONSEQUENTIAL DAMAGES.**

If this product is sold as part of a Hewlett-Packard integrated instrument system, the above warranty shall not be applicable, and this product shall be covered only by the system warranty.

Service contracts or customer assistance agreements are available for Hewlett-Packard products.

For any assistance, contact your nearest Hewlett-Packard Sales and Service Office. Addresses are provided at the back of this manual.

## SECTION I GENERAL INFORMATION

### 1-1. DESCRIPTION.

1-2. The Hewlett-Packard Models 333A and 334A Distortion Analyzers are solid state instruments for measuring distortion on ac voltages. The Models 333A and 334A include two control loops that automatically tune both legs of a bridge circuit which rejects the fundamental when the rejection circuit is initially set within the range of the loops. The 334A has a high impedance detector which operates from 550 kHz to greater than 65 MHz and provides the capability of monitoring the distortion of the amplitude modulation on an rf carrier.

1-3. Distortion levels of 0.1% to 100% full scale are measured in seven ranges for any fundamental frequency of 5 Hz to 600 kHz. Harmonics are indicated up to 3 MHz. The high sensitivity of these instruments requires only 0.3V rms for the 100% set level reference. The distortion characteristics can be monitored at the OUTPUT connectors with an oscilloscope, a true rms voltmeter, or a wave analyzer. The instruments are capable of an isolation voltage of 400 volts above chassis ground.

1-4. The voltmeter can be used separately for general purpose voltage and gain measurements. It has a frequency range of 5 Hz to 3 MHz (20 Hz to 500 kHz for 300  $\mu$ V range) and a voltage range of 300 $\mu$ V to 300 V rms full scale.

1-5. The AM detector included in the Model 334A is a broadband dc restoring peak detector consisting of a semiconductor diode and filter circuit. AM distortion levels as low as 0.3% can be measured on a 3 V to 8 V rms carrier modulated 30% in the standard broadcast band. Distortion less than 1% can be measured at the same level of the carrier up to 65 Mc.

### 1-6. ACCESSORY FEATURES.

1-7. The accessory available with the 333A and 334A Distortion Analyzers is a voltage divider probe, -hp- Model No. 10001A. The features of the probe are:

- a. 10 megohms shunted by 10 pF, giving 10:1 attenuation.
- b. DC to 30 MHz bandwidth.
- c. 2% division accuracy.
- d. 600 V peak input.
- e. 5 ns rise-time.

### 1-8. OPTION.

1-9. Option 01 is a standard -hp- Model 333A or 334A with a special meter and meter amplifier, compensated to permit response to VU (volume units) characteristics.

### 1-10 INSTRUMENT IDENTIFICATION.

1-11. Hewlett-Packard uses a two-section serial number. The first section (prefix) identifies a series of instruments. The last section (suffix) identifies a particular instrument within the series. If a letter is included with the serial number, it identifies the country in which the instrument was manufactured. If the serial prefix of your instrument differs from the one on the title page of this manual, a change sheet will be supplied to make this manual compatible with newer instruments or the backdating information in Appendix C will adapt this manual to earlier instruments. All correspondence with Hewlett-Packard should include the complete serial number.

Table 1-1. Specifications

MODEL 333A		Fundamental Input Greater Than 30 V		
<b>DISTORTION MEASUREMENT RANGE</b> Any fundamental frequency, 5 Hz to 600 kHz. Distortion levels of 0.1%-100% are measured full scale in 7 ranges.				
<b>DISTORTION MEASUREMENT ACCURACY</b> Harmonic measurement accuracy (full scale) Fundamental Input Less Than 30 V				
RANGE	$\pm 3\%$	$\pm 6\%$	$\pm 12\%$	
100%-0.3%	10 Hz 1 MHz	10 Hz 3 MHz		
0.1%	30 Hz 300 kHz	20 Hz 500 kHz	10 Hz 1.2 MHz	
<b>Elimination Characteristics:</b> Fundamental Rejection > 80 dB Second Harmonic Accuracy for a fundamental of: 5 Hz to 20 Hz: better than +1 dB 20 Hz to 20 kHz: better than $\pm 0.6$ dB 20 kHz to 100 kHz: better than -1 dB 100 kHz to 300 kHz: better than -2 dB 300 kHz to 600 kHz: better than -3 dB				

Table 1-1. Specifications (Cont'd)

<p><b>Distortion Introduced by Instrument:</b>                  &gt; -70 dB from 5 Hz to 200 kHz                  &gt; -64 dB from 200 kHz to 600 kHz</p> <p>Meter indication is proportional to the average value of a waveform.</p> <p><b>FREQUENCY CALIBRATION ACCURACY</b>                  Better than <math>\pm 5\%</math> from 5 Hz to 300 kHz                  Better than <math>\pm 10\%</math> from 300 kHz to 600 kHz</p> <p><b>INPUT IMPEDANCE</b>                  Distortion Mode: <math>1\text{ M}\Omega \pm 5\%</math> shunted by <math>&lt;70\text{ pF}</math>.                  Voltmeter Mode:  <math>1\text{ M}\Omega \pm 5\%</math> shunted by <math>&lt;30\text{ pF}</math> (333A only),  <math>1\text{ M}\Omega \pm 5\%</math> shunted by <math>&lt;35\text{ pF}</math> (334A only),                  1 to 300 V ranges; <math>1\text{ M}\Omega \pm 5\%</math> shunted by <math>&lt;70\text{ pF}</math>,                  300 <math>\mu\text{V}</math> to 0.3 V ranges.</p> <p><b>INPUT LEVEL FOR DISTORTION MEASUREMENTS</b>                  0.3 V rms for 100% set level (up to 300 V may be attenuated to set level reference). The minimum measurable distortion for floating operation on the X1 frequency range is 50dB below the fundamental.</p> <p><b>DC ISOLATION</b>                  Signal ground may be <math>\pm 400\text{ Vdc}</math> from external chassis.</p> <p><b>VOLTMETER RANGE</b>                  300 <math>\mu\text{V}</math> to 300 V rms full scale (13 ranges),                  10 dB per range.</p> <p><b>VOLTMETER FREQUENCY RANGE</b>                  5 Hz to 3 MHz (300 <math>\mu\text{V}</math> range: 20 Hz-500 kHz).</p> <p><b>VOLTMETER ACCURACY:</b></p> <table border="1" style="width: 100%; border-collapse: collapse;"> <thead> <tr> <th style="text-align: center;">RANGE</th> <th style="text-align: center;"><math>\pm 2\%</math></th> <th style="text-align: center;"><math>\pm 5\%</math></th> </tr> </thead> <tbody> <tr> <td style="text-align: center;">300 <math>\mu\text{V}</math></td> <td style="text-align: center;">30 Hz-300 kHz</td> <td style="text-align: center;">20 Hz-500 kHz</td> </tr> <tr> <td style="text-align: center;">1 mV-30 V</td> <td style="text-align: center;">10 Hz-1 MHz</td> <td style="text-align: center;">5 Hz-3 MHz</td> </tr> <tr> <td style="text-align: center;">100 V-300 V</td> <td style="text-align: center;">10 Hz-300 kHz</td> <td style="text-align: center;">5 Hz-500 kHz</td> </tr> </tbody> </table>	RANGE	$\pm 2\%$	$\pm 5\%$	300 $\mu\text{V}$	30 Hz-300 kHz	20 Hz-500 kHz	1 mV-30 V	10 Hz-1 MHz	5 Hz-3 MHz	100 V-300 V	10 Hz-300 kHz	5 Hz-500 kHz	<p><b>NOISE MEASUREMENTS</b>                  Voltmeter residual noise on the 300 <math>\mu\text{V}</math> range:  <math>&lt; 25\text{ }\mu\text{V rms}</math> terminated in shielded 600<math>\Omega</math>; <math>&lt; 30\text{ }\mu\text{V rms}</math> terminated in shielded 100 k<math>\Omega</math>.</p> <p><b>OUTPUT</b>                  For input frequencies from 20 Hz to 600 kHz, 0.1 V rms <math>\pm 0.01\text{ V}</math> open circuit for full scale meter deflection; 0.05 V rms <math>\pm 0.005\text{ V}</math> into 2 k<math>\Omega</math> for full scale meter deflection.</p> <p><b>AUTOMATIC NULLING MODE</b>                  Set Level: At least 0.2 V rms.                  Frequency Ranges:                  X1, manual null tuned to less than 3% of set level; total frequency hold-in <math>\pm 0.5\%</math> about true manual null.                   X10 through X10K, manual null tuned to less than 10% of set level; total frequency hold-in <math>\pm 1\%</math> about true manual null.</p> <p><b>AUTOMATIC NULL ACCURACY</b>                  5 Hz to 100 Hz: Meter reading within 0 to +3 dB of manual null.                   100 Hz to 600 kHz: Meter reading within 0 to +1.5 dB of manual null.</p> <p><b>HIGH-PASS FILTER</b>                  3 dB point at 400 Hz with 18 dB per octave roll off. 60 Hz rejection <math>&gt; 40\text{ dB}</math>. Normally used only with fundamental frequencies greater than 1 kHz.</p> <p><b>POWER SUPPLY</b>                  100 V/120 V/220 V/240 V <math>\pm 5\% - 10\%</math>, 48 - 66 Hz, approximately 4 watts.</p>
RANGE	$\pm 2\%$	$\pm 5\%$											
300 $\mu\text{V}$	30 Hz-300 kHz	20 Hz-500 kHz											
1 mV-30 V	10 Hz-1 MHz	5 Hz-3 MHz											
100 V-300 V	10 Hz-300 kHz	5 Hz-500 kHz											
<p style="text-align: center;"><b>MODEL 334A</b></p> <p>Same as Model 333A except as indicated below:</p> <p><b>AM DETECTOR</b>                  High impedance dc restoring peak detector with semi-conductor diode operates from 550kHz to greater than 65 MHz. Broadband input. Maximum input; 40 V p-p ac or 40 V peak transient.</p> <p><b>CARRIER FREQUENCY</b>                  550kHz to 1.6 MHz: Distortion introduced by detector is <math>&lt; 0.3\%</math> for 3 to 8 volt carriers modulated 30%.</p>	<p>1.6 MHz to 65 MHz: Distortion introduced by detector is <math>&lt; 1\%</math> for 3 to 8 volts rms carriers modulated 30%.</p> <p style="text-align: center;">————— NOTE —————</p> <p>Distortion measurement at carrier levels as low as 1 volt may be made with reduced accuracy.</p> <p><b>OPTION: 01</b>                  Indicating meter has VU characteristics conforming to FCC Requirements for AM, FM, and TV broadcasting.</p>												

## SECTION II INSTALLATION

### 2-1. INTRODUCTION.

2-2. This section contains information and instructions necessary for the installation and shipping of the Models 333A/334A Distortion Analyzers. Included are initial inspection procedures, power and grounding requirements, installation information, and instructions for repackaging for shipment.

### 2-3. INSPECTION.

2-4. This instrument was carefully inspected both mechanically and electrically before shipment. It should be physically free of marks or scratches and in perfect electrical order upon receipt. To confirm this, the instrument should be inspected for physical damage in transit. Also check for supplied accessories, and test the electrical performance of the instrument using the procedure outlined in Paragraph 5-5. If there is damage or deficiency, see the warranty on the inside front cover of this manual.

### 2-5. POWER REQUIREMENTS.

2-6. The Model 333A/334A can be operated from any ac source of 100 V/120 V/220 V/240 V + 5% - 10%, 48 - 66 Hz. With the instrument disconnected from the ac power source, move the slide (located on the rear panel) until the desired line voltage appears. Power dissipation is approximately 4 watts.

### 2-7. THREE-CONDUCTOR POWER CABLE.

2-8. To protect operating personnel, the National Electrical Manufacturers' Association (NEMA) recommends that the instrument panel and cabinet be grounded. All Hewlett-Packard instruments are equipped with a three-conductor power cable, which, when plugged into an appropriate receptacle, grounds the instrument. The offset pin on the power cable three-prong connector is the ground wire.

### 2-9. INSTALLATION.

2-10. The Model 333A/334A is fully transistorized; therefore, no special cooling is required. However, the instrument should not be operated where the ambient temperature exceeds 55°C (131°F).

### 2-11. BENCH INSTALLATION.

2-12. The Model 333A/334A is shipped with plastic feet and tilt stand in place, ready for use as a bench instrument.

### 2-13. RACK INSTALLATION.

2-14. The Model 333A/334A may be rack mounted by using the 5" RackMount Kit (-hp- Part No. 5060-0775).

Instructions for the conversion are included with the kit. The rack mount for the Model 333A/334A is an EIA standard width of 19 inches. When mounted in a rack using the rack mount kit, additional support at the rear of the instrument should be provided if vibration or similar stress is likely.

### 2-15. REPACKAGING FOR SHIPMENT.

2-16. The following paragraphs contain a general guide for repackaging of the instrument for shipment. Refer to Paragraph 2-17 if the original container is to be used; 2-18 if it is not. If you have any questions, contact your local -hp- Sales and Service Office. (See Appendix B for office locations.)

#### ————— NOTE —————

If the instrument is to be shipped to Hewlett-Packard for service or repair, attach a tag to the instrument identifying the owner and indicate the service or repair to be accomplished. Include the model number and full serial number of the instrument. In any correspondence, identify the instrument by model number, serial number, and serial number prefix.

2-17. If original container is to be used, proceed as follows:

a. Place instrument in original container if available. If original container is not available, a suitable one can be purchased from your nearest -hp- Sales and Service Office.

b. Ensure that container is well sealed with strong tape or metal bands.

2-18. If original container is not to be used, proceed as follows:

a. Wrap instrument in heavy paper or plastic before placing in an inner container.

b. Place packing material around all sides of instrument and protect panel face with cardboard strips.

c. Place instrument and inner container in a heavy carton or wooden box and seal with strong tape or metal bands.

d. Mark shipping container with "DELICATE INSTRUMENT," "FRAGILE," etc.

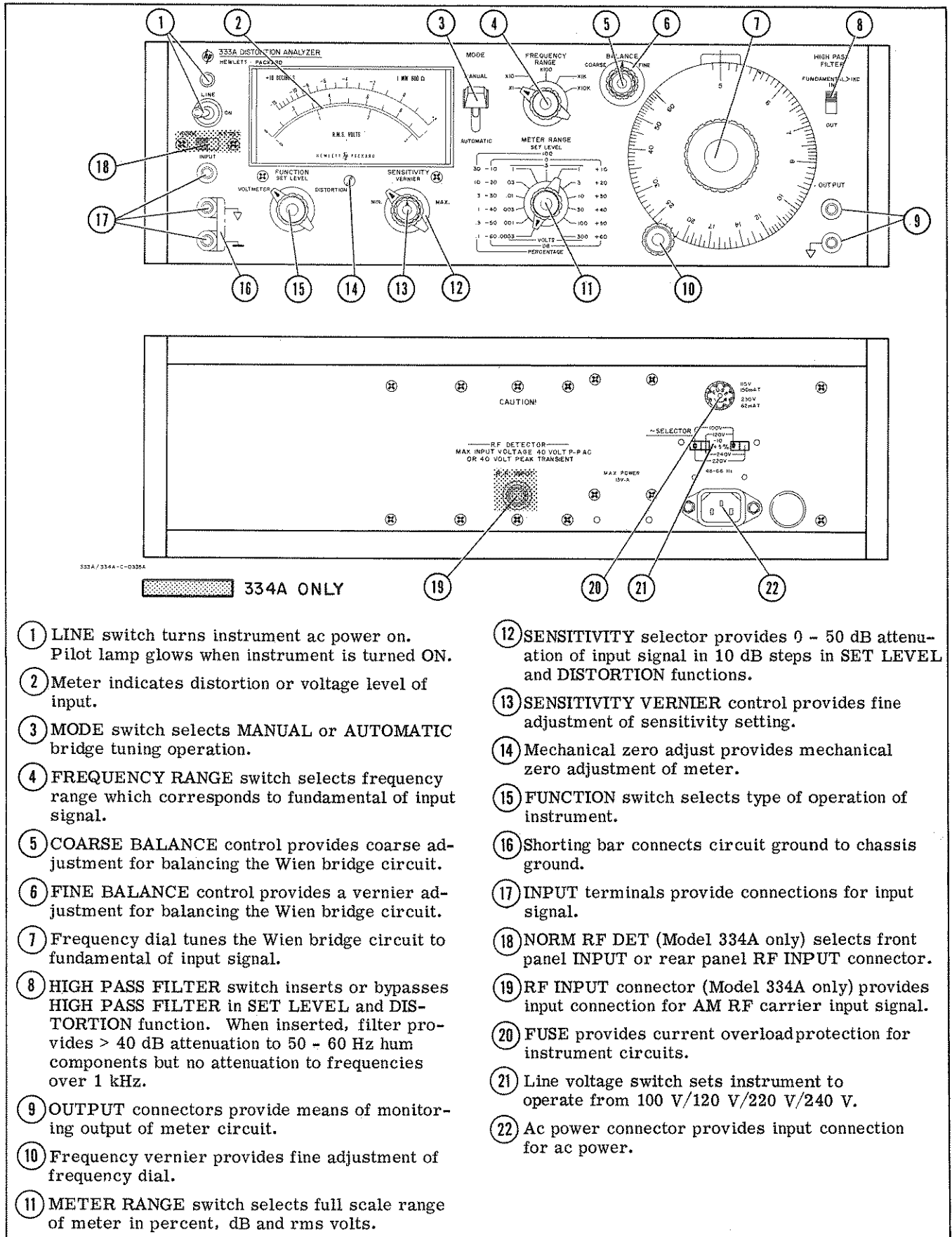

- ① LINE switch turns instrument ac power on. Pilot lamp glows when instrument is turned ON.
- ② Meter indicates distortion or voltage level of input.
- ③ MODE switch selects MANUAL or AUTOMATIC bridge tuning operation.
- ④ FREQUENCY RANGE switch selects frequency range which corresponds to fundamental of input signal.
- ⑤ COARSE BALANCE control provides coarse adjustment for balancing the Wien bridge circuit.
- ⑥ FINE BALANCE control provides a vernier adjustment for balancing the Wien bridge circuit.
- ⑦ Frequency dial tunes the Wien bridge circuit to fundamental of input signal.
- ⑧ HIGH PASS FILTER switch inserts or bypasses HIGH PASS FILTER in SET LEVEL and DISTORTION function. When inserted, filter provides > 40 dB attenuation to 50 - 60 Hz hum components but no attenuation to frequencies over 1 kHz.
- ⑨ OUTPUT connectors provide means of monitoring output of meter circuit.
- ⑩ Frequency vernier provides fine adjustment of frequency dial.
- ⑪ METER RANGE switch selects full scale range of meter in percent, dB and rms volts.
- ⑫ SENSITIVITY selector provides 0 - 50 dB attenuation of input signal in 10 dB steps in SET LEVEL and DISTORTION functions.
- ⑬ SENSITIVITY VERNIER control provides fine adjustment of sensitivity setting.
- ⑭ Mechanical zero adjust provides mechanical zero adjustment of meter.
- ⑮ FUNCTION switch selects type of operation of instrument.
- ⑯ Shorting bar connects circuit ground to chassis ground.
- ⑰ INPUT terminals provide connections for input signal.
- ⑱ NORM RF DET (Model 334A only) selects front panel INPUT or rear panel RF INPUT connector.
- ⑲ RF INPUT connector (Model 334A only) provides input connection for AM RF carrier input signal.
- ⑳ FUSE provides current overload protection for instrument circuits.
- ㉑ Line voltage switch sets instrument to operate from 100 V/120 V/220 V/240 V.
- ㉒ Ac power connector provides input connection for ac power.

Figure 3-1. Front and Rear Panel Description

## SECTION III OPERATING INSTRUCTIONS

### 3-1. INTRODUCTION.

3-2. The Models 333A and 334A Distortion Analyzers measure total harmonic distortion of fundamental frequencies from 5 Hz to 600 kHz; harmonics upto 3 MHz are included. The sharp elimination characteristics (>80 dB), the low level of instrument induced distortion, and the meter accuracy of these instruments result in highly accurate measurement of low level harmonic distortion.

3-3. An rms calibrated voltmeter is inherent in the 333A and 334A. The voltmeter provides a full scale sensitivity of 300  $\mu$  volts rms (residual noise <25 $\mu$  volts). The voltmeter frequency range is from 5 Hz to 3 MHz except on the 0.0003 volt range, which is from 20 Hz to 500 kHz.

### 3-4. CONTROLS AND INDICATORS.

3-5. Figure 3-1 illustrates and describes the function of all front and rear panel controls, connectors, and indicators. The description of each component is keyed to the drawing included within the figure.

### 3-6. GENERAL OPERATING INFORMATION.

#### 3-7. INPUT CONNECTIONS.

3-8. The input signal can be connected to the 333A and 334A through twisted pair leads or a shielded cable with banana plug connectors. Keep all test leads as short as possible to avoid extraneous pickup from stray ac fields. When measuring Low-level signals, ground loops may occur causing erroneous readings. Ground loops may be avoided by connecting the 333A/334A Distortion Analyzer to an appropriate isolation transformer to break the chassis ground from power supply ground. Connect all other instruments to one power strip with the three-prong connectors as close as possible.

#### 3-9. VOLTMETER CHARACTERISTICS.

3-10. The RMS VOLTS markings on the meter face are based on the ratio between the average and effective (rms) values of a pure sine wave. The ratio of average to effective values in a true sine wave is approximately 0.9 to 1. When the meter is used to measure complex waves, the voltage indicated may not be the rms value of the signal applied. This deviation of meter indication exists because the ratios of average to effective values are usually not the same in a complex wave as in a sine wave. The amount of deviation depends on the magnitude and phase relation between the harmonics and fundamental frequency of the signal applied. Table 3-1 lists the deviation of the meter indication of a sine wave partly distorted by harmonics. As indicated in the table, harmonic content of less than 10% results in very small errors.

Table 3-1  
Effect of Harmonics on Voltage Measurements

Input Voltage Characteristics	True RMS Value	Meter Indication
Fundamental = 100	100	100
Fundamental + 10% 2nd harmonic	100.5	100
Fundamental + 20% 2nd harmonic	102	100 - 102
Fundamental + 50% 2nd harmonic	112	100 - 110
Fundamental + 10% 3rd harmonic	100.5	96 - 104
Fundamental + 20% 3rd harmonic	102	94 - 108
Fundamental + 50% 3rd harmonic	112	90 - 116

————— NOTE —————

This chart is universal in application since these errors are inherent in all average-responding voltage-measuring instruments.

3-11. When making distortion measurements where the fundamental frequency is suppressed and the remainder of the signal is measured, the reading obtained on an average responding meter may deviate from the true total rms value. When the residual wave contains many inharmonically related sinusoids, the maximum error in the distortion reading is about 11 % (11 % of the measured distortion) low for distortion levels below 10 %.

**EXAMPLE:**

Measured Distortion	Maximum Error In Meter Indication	Total Distortion
2.5%	+0.11x0.025= 0.00027	0.025+0.0027= 0.0277 or 2.8%

This example represents the maximum possible error, and in most cases the error is less. In distortion measurements, the reading of an average-responding meter is sufficiently close to the rms value to be satisfactory for most applications.

#### 3-12. OUTPUT TERMINALS.

3-13. The OUTPUT terminals provide a 0.1 V rms open circuit output for full scale meter deflection. These terminals can be used to monitor the output signal with an oscilloscope, a true rms voltmeter, or a wave analyzer. The combination of the distortion meter and oscilloscope provides more significant in-

formation about the device under test than the expression of distortion magnitude alone. Information obtained from the oscilloscope pattern is specific and reveals the nature of distortion which sometimes occurs at such low levels that it is difficult to detect in the presence of hum and noise. The impedance at the OUTPUT terminals is 2000 ohms, therefore, capacitive loads greater than 50 pF should be avoided to maintain the accuracy of meter readings.

### 3-14. OPERATING PROCEDURES.

#### 3-15. INSTRUMENT TURN-ON.

- a. Set the 115-230 VAC switch to coincide with the line voltage in use. Turn switch to ON position. Pilot lamp will glow, indicating application of primary power.

#### 3-16. ADJUSTMENT OF METER MECHANICAL ZERO.

3-17. The meter is properly zero-set when the pointer rests over the zero calibration mark and the instrument is in its normal operating environment and is turned off. Zero-set the meter as follows to obtain maximum accuracy and mechanical stability:

- a. Turn instrument on and allow it to operate for at least 20 minutes, to let meter movement reach normal operating temperature.
- b. Turn instrument off and allow 30 seconds for all capacitors to discharge.
- c. Rotate zero adjustment screw clockwise until pointer is left of zero and moving upscale.
- d. Continue rotating screw clockwise; stop when pointer is exactly at zero.
- e. When pointer is exactly over zero, rotate adjustment screw slightly counterclockwise to relieve tension on pointer suspension. If pointer moves off zero, repeat steps c through e, but make counterclockwise rotation less.

#### 3-18. DISTORTION MEASUREMENT.



DO NOT EXCEED THE INPUT VOLTAGES LISTED BELOW TO PREVENT DAMAGING COMPONENTS ON A2 BOARD.

VOLTMETER FUNCTION -1V RANGE AND BELOW, AND DISTORTION ANALYZER FUNCTION - MAXIMUM SENSITIVITY.

1. 300 V ABOVE 100 Hz
2. 50 V ABOVE 1 kHz

#### 3-19. MANUAL MODE.

- a. Turn instrument on and mechanically zero meter according to procedure in Paragraphs 3-15 and 3-16.

- b. Set NORM-R. F. DET. switch to NORM.
- c. Set FUNCTION switch to SET LEVEL.
- d. Set MODE switch to MANUAL.
- e. If fundamental frequency is 1 kHz or greater, set HIGH PASS FILTER switch to IN.
- f. Set SENSITIVITY selector to MIN. position, and rotate VERNIER control maximum counterclockwise.

#### ————— NOTE —————

The bandwidth of the SENSITIVITY selector is reduced in the two extreme CCW positions (positions used with an input signal greater than 30 V).

- g. Set METER RANGE switch to SET LEVEL, and set BALANCE COARSE and FINE controls to center position.
- h. Connect signal to be measured to 333A/334A INPUT terminals.

#### WARNING

REMOVE SHORTING STRAP BETWEEN FRAME GROUND (⊥) AND CHASSIS GROUND (∇) TERMINALS ON FRONT PANEL INPUT TERMINALS WHEN MEASURING DISTORTION BETWEEN TWO POINTS WHICH ARE DC OFFSET FROM GROUND POTENTIAL.

- i. Set SENSITIVITY selector to obtain meter indication greater than 1/3 full scale.
- j. Adjust SENSITIVITY VERNIER for full scale meter indication if making distortion measurement in percent; if making distortion measurement in dB adjust SENSITIVITY VERNIER for 0 dB meter indication.

#### ————— NOTE —————

If unable to adjust for full scale or 0dB indication, (which indicates input signal is below 0.3 volts), set METER RANGE selector down-scale. Use this new setting as the 100% or 0dB SET LEVEL position, thus making the next range 30% or -10 dB, etc.

- k. Set FREQUENCY RANGE switch and frequency dial to fundamental frequency of input signal.
- l. Set FUNCTION switch to DISTORTION.
- m. Adjust frequency dial vernier and BALANCE COARSE and FINE controls for minimum



meter indication. Set METERRANGE switch down-scale as necessary to keep meter indication on scale.

- n. Repeat step m until no further reduction in meter indication can be obtained.
- o. Observe distortion either in percentage or dB, as indicated by meter deflection and METER RANGE switch setting. For example, if meter indicates 0.4 and METER RANGE setting is 1%, distortion measured is 0.4% of fundamental. Similarly, if meter indicates -6 dB and METER RANGE setting is -40 dB, distortion measured is -46 dB from fundamental.

————— NOTE —————

In MANUAL mode the accuracy of distortion measurements is affected by frequency stability of the input signal. An inaccuracy in distortion indications occurs when the frequency drift of the input signal exceeds the bandwidth of the rejection curve.

- p. If desired, rms voltage of input signal can be measured by setting FUNCTION switch to VOLTMETER, and setting METER RANGE switch to obtain an on-scale indication.

### 3-20. AUTOMATIC MODE.

- a. Perform steps a through l of Paragraph 3-19.
- b. Adjust frequency dial vernier and BALANCE COARSE and FINE controls for minimum meter indication.
- c. When meter indication is less than 10% of SET LEVEL indication, set MODE switch to AUTOMATIC. (If fundamental cannot be manually nulled below 10% of SET LEVEL indication, automatic mode cannot be used).
- d. Set METER RANGE switch down-scale to obtain on-scale meter indication.
- e. Observe distortion either in percentage or dB, as indicated by meter deflection and METER RANGE switch setting. For example, if meter indicates 0.4 and METER RANGE setting is 1%, distortion measured is 0.4% of fundamental. Similarly, if meter indicates -6 dB and METER RANGE setting is -40 dB, distortion measured is -46 dB from fundamental.
- f. If desired, rms voltage of input signal can be measured by setting FUNCTION switch to VOLTMETER, and setting METER RANGE switch to obtain an on-scale indication.

### 3-21. DISTORTION MEASUREMENT OF AM RF CARRIERS (334A only).



DO NOT EXCEED MAXIMUM INPUT VOLTAGES LISTED ON REAR PANEL.

- a. Turn instrument on and mechanically zero meter according to procedure in Paragraphs 3-15 and 3-16.
- b. Set NORM.-R. F. DET. switch to R. F. DET.
- c. Connect input signal to R. F. INPUT terminal on rear panel.
- d. Refer to Paragraph 3-19 for manual distortion measurement; refer to Paragraph 3-20 for automatic distortion measurement.

————— NOTE —————

If no meter deflection can be obtained with an RF input, diode A4CR1 should be checked. A spare diode is located on the outside of the A4 shield.

### 3-22. VOLTAGE MEASUREMENT.

- a. Turn instrument on and mechanically zero meter according to procedure in Paragraphs 3-15 and 3-16.
- b. Set NORM.-R. F. DET. switch to NORM.
- c. Set FUNCTION switch to VOLTMETER.
- d. Set METER RANGE switch to a range exceeding amplitude of signal to be measured.
- e. Connect signal to be measured to INPUT terminals.
- f. Set METER RANGE switch to give a reading as close to full scale as possible, and observe meter indication.
- g. The dB scale of the 333A/334A is calibrated in dBm, such that 0 dBm = 1 milliwatt dissipated by 600 ohms. Therefore, a dBm measurement must be made across 600 ohms. However, dB measurements across other impedances can be converted to dBm by use of the Impedance Correction Graph of Figure 3-3. For example: to convert a -30 dB reading across 200 ohms to dBm, locate the 200 ohm impedance line at the bottom of the graph. Follow the impedance line to the heavy black line, and read the meter correction at that point. The correction for 200 ohms is +5 dBm; thus the corrected reading is -25 dBm.

3-23. METER INDICATION.

3-24. The 333A/334A meter is calibrated to indicate in both dB and volts. It is interesting to note that the METER RANGE markings differ from most ac voltmeter range markings. On most ac voltmeters (600 ohms) 0 dB corresponds to the 1 volt range. This is not true in the case of the 333A/334A. Since the instrument is primarily a distortion analyzer, measurements are in dB (relative measurement) rather than in dBm (absolute measurement). Zero dB on the 333A/334A corresponds to 0.3 volt range rather than the 1 volt range. This allows a 10 dB greater dynamic range of distortion measurements.

3-25. If measurements are to be made in dBm, 10 dB must be subtracted from the METER RANGE setting. Thus 0 dB becomes the -10 dBm range for absolute power measurements. Zero dBm is equal to 1 milliwatt dissipated by any impedance and in this particular case is 600 ohms. The +10 DECIBELS marking on the meter face indicates that when voltmeter measurements are being made, the indication (METER RANGE plus meter indication) is 10 dB greater than when power (dBm) measurements are being made.

3-26. In short, when distortion and voltage measurements are being made, utilize the instrument METER RANGE and meter scale as they exist. For absolute power measurements in dBm, simply subtract 10 dB from the METER RANGE setting.

3-27. USE OF OUTPUT TERMINALS.

3-28. In VOLTMETER and SET LEVEL functions, the 333A/334A can be used as a low distortion, wide-band amplifier. A portion of the meter input (0.1 V rms open circuit for full scale meter deflection) is provided at the OUTPUT terminals.

3-29. In DISTORTION function, the distortion (0.1 V rms open circuit for full scale deflection) is provided at the OUTPUT terminals for monitoring purposes.

————— NOTE —————











The INPUT  $\nabla$  terminal and the OUTPUT  $\nabla$  terminal should not be connected directly together when making low level measurements. These terminals are isolated from each other by 1 ohm which reduces the effects of common mode voltages.

3-30. 333A/334A WITH OPTION 01.

3-31. Operating procedures for the 333A/334A with Option 01 are the same as for the standard instrument. The only difference between the standard and optional instrument is that the Option 01 has a special meter and meter amplifier which is compensated to respond to VU (volume unit) characteristics.

3-32. MANUAL NULLING.

3-33. Since the frequency and balance controls are rather sensitive in the MANUAL mode, the following information is supplied to simplify nulling the 333A/334A in the MANUAL mode. When nulling the 333A/334A in the MANUAL mode, connect the equipment as shown below and adjust the 333A/334A frequency and balance controls for the waveform shown in step a below. Additional waveforms are provided to simplify nulling.

- a.  No harmonic distortion. Frequency and balance adjustment correct.
- b.  Frequency and balance control improperly adjusted.
- c.  Frequency approximately correct; balance incorrect.
- d.  Balance approximately correct; frequency incorrect.
- e.  Second harmonic predominant; frequency and balance adjusted.
- f.  Second harmonic predominant; frequency and balance adjusted; phase changed.
- g.  Second harmonic predominant; frequency and balance adjusted; phase changed.
- h.  Third harmonic predominant.
- i.  Balance incorrect; meter reading off scale.
- j.  Frequency incorrect; meter reading off scale.

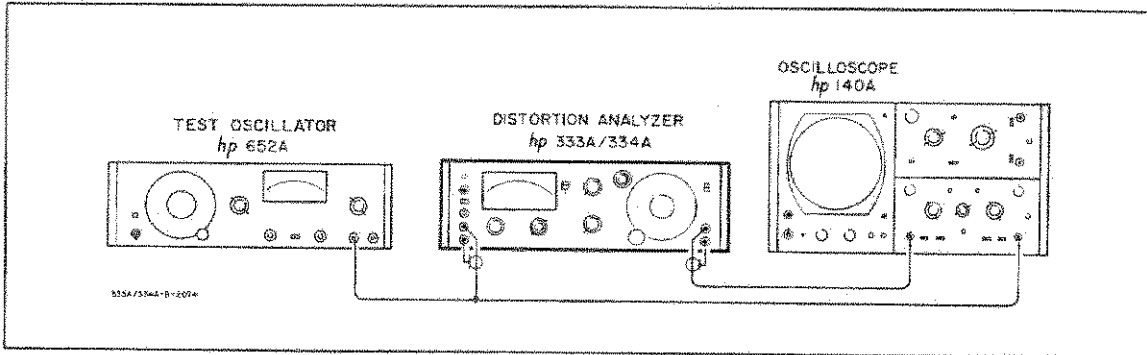

Figure 3-2. Manual Nulling Test Setup.

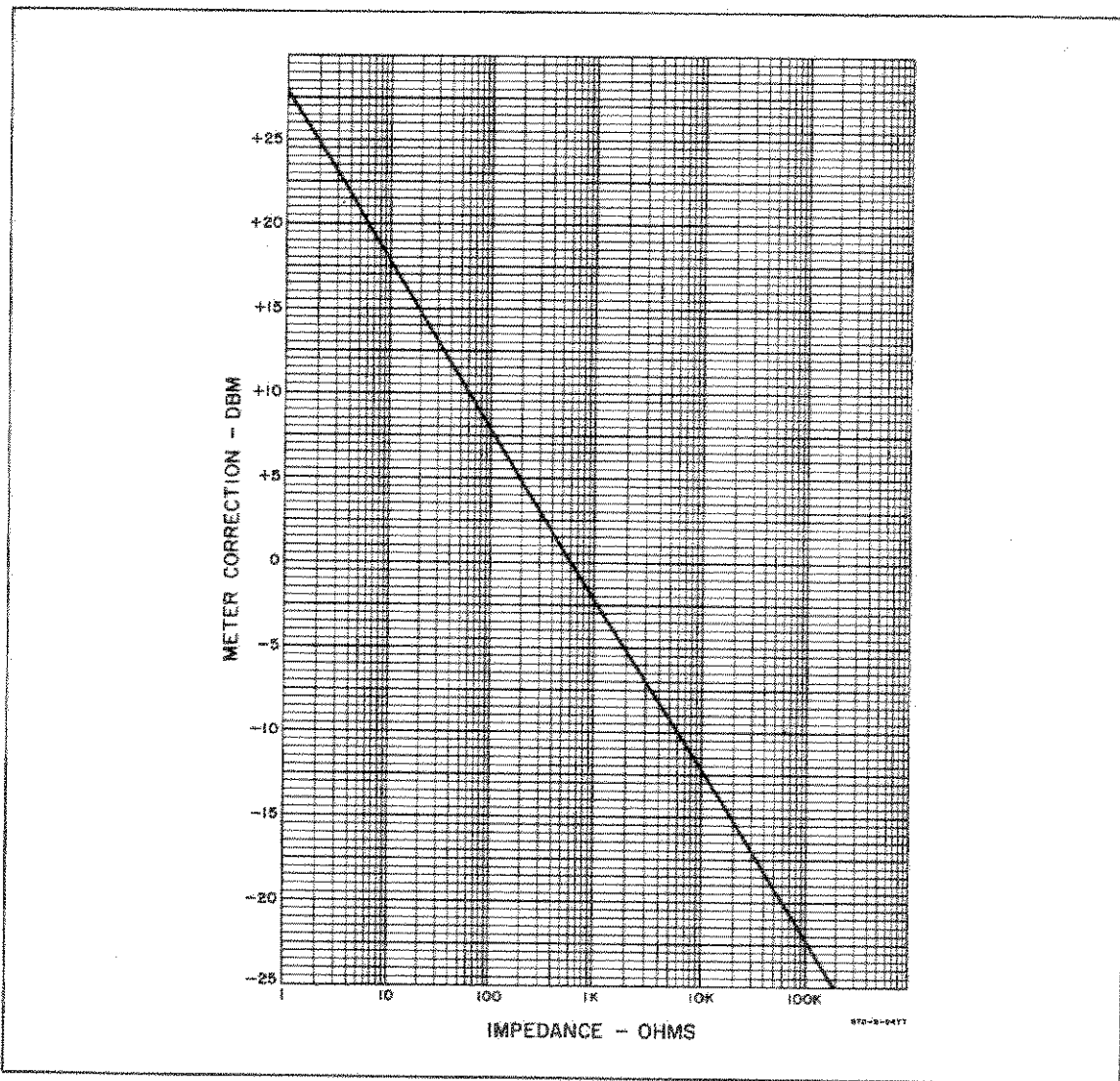

Figure 3-3. Impedance Correction Graph.

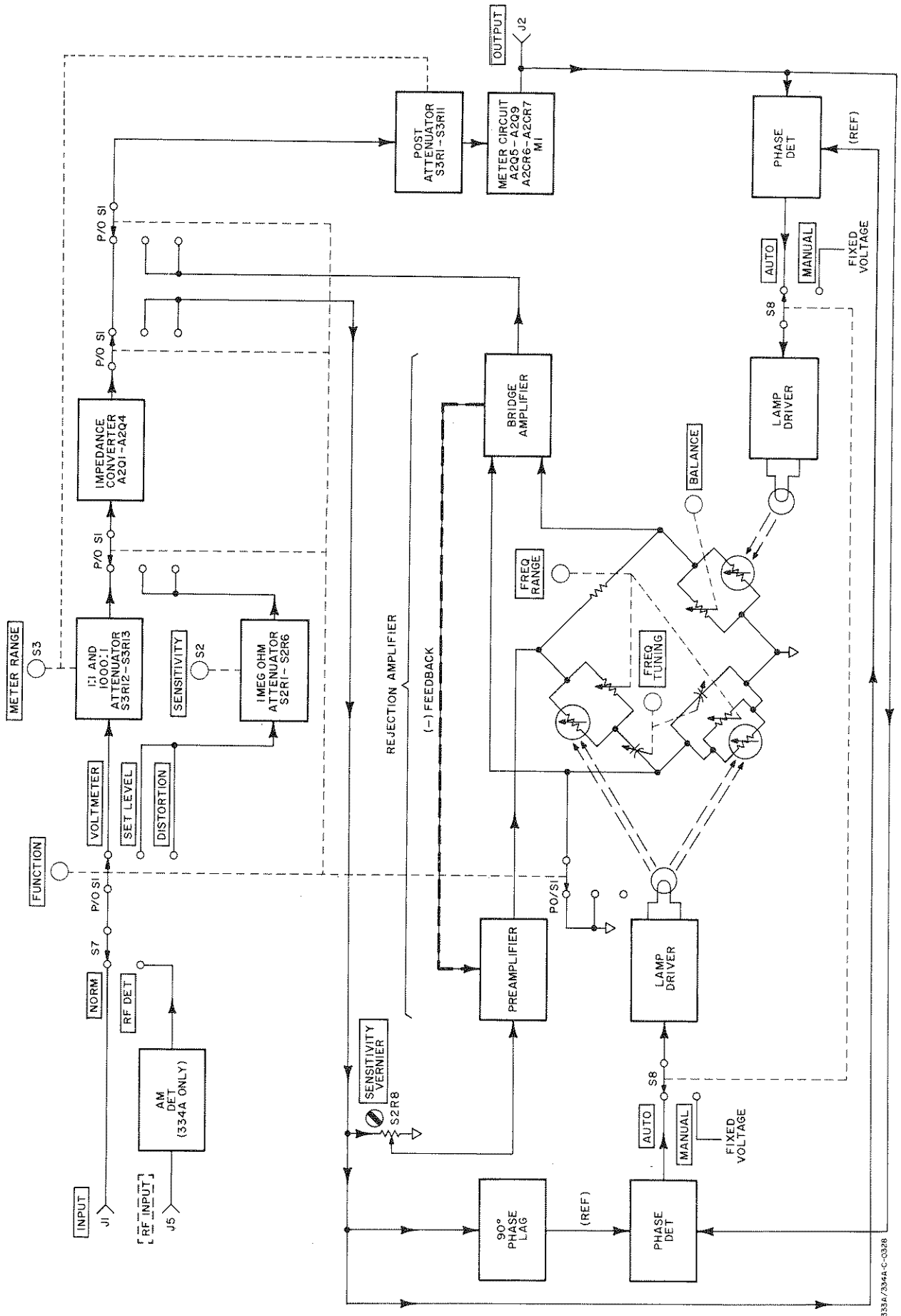

Figure 4-1. Block Diagram

## SECTION IV

### THEORY OF OPERATION

#### 4-1. OVERALL DESCRIPTION.

4-2. Models 333A and 334A Distortion Analyzers include an impedance converter, a rejection amplifier, a metering circuit, and a power supply. The Model 334A also contains an AM detector. The impedance converter provides a low noise input circuit with a high input impedance independent of source impedance placed at the INPUT terminals. The rejection amplifier rejects the fundamental frequency of the input signal and passes the remaining frequency components on to the metering circuit for measuring distortion. The metering circuit provides visual indications of distortion and voltage levels on the front panel meter, M1. The AM detector (Model 334A only) detects the modulating signal from the RF carrier and filters all RF components from the modulating signal before it is applied to the impedance converter circuit.

#### 4-3. BLOCK DIAGRAM DESCRIPTION.

(Refer to Figure 4-1)

#### 4-4. DISTORTION MEASURING OPERATION.

4-5. For distortion measurement, the input signal is applied to the impedance converter (Assembly A2) through the FUNCTION selector, S1, and the one megohm attenuator. The one megohm attenuator is a voltage divider network which provides 50 dB attenuation in 10 dB steps. The desired level of attenuation is selected by the SENSITIVITY selector, S2. The impedance converter provides impedance matching and unity gain between the INPUT terminals and the input of the rejection amplifier.

4-6. The rejection amplifier consists of a preamplifier, a Wien bridge, and a bridge amplifier. The SENSITIVITY VERNIER control, at the input of the preamplifier, provides a set level signal to obtain a full scale reading on the meter for any voltage level at the input of the instrument. With the FUNCTION switch in the SET LEVEL position, a ground is applied to the Wien bridge circuit to allow a signal reference level to be set up on the meter. With the FUNCTION switch in the DISTORTION position, the Wien bridge is used as an interstage coupling network between the preamplifier and bridge amplifier. The Wien bridge is then tuned and balanced to reject the fundamental frequency of the applied input signal. Two automatic control loops consisting of two phase detectors, lamp drivers, lamps, and photocells provide fine tuning and balance in the AUTOMATIC MODE. The remaining frequency components are applied to the bridge amplifier and are measured as distortion by the metering circuit. Negative feedback from the bridge amplifier to the preamplifier narrows the rejection response of the Wien bridge.

4-7. The output of the rejection amplifier is applied to the metering circuit through the post-attenuator. The post-attenuator is used to limit the input signal

level applied to the metering circuit to 1 mV for full scale deflection. Sensitivity of the metering circuit is increased to 300  $\mu$ V for full scale deflection on the .0003V range. The metering circuit provides a visual indication of the distortion level of the input signal. In addition to the indication provided by the meter, the OUTPUT terminals provide a means of monitoring the distortion components.

#### 4-8. DISTORTION MEASUREMENT IN AM CARRIERS.

4-9. The Model 334A Distortion Analyzer contains an AM detector circuit for measuring envelope distortion in AM carriers. The input signal is applied to the input of the AM detector circuit where the modulating signal is recovered from the RF carrier. The signal is then applied to the impedance converter circuit through the one megohm attenuator and then through the same circuits previously described in the distortion measuring mode operation.

#### 4-10. VOLTMETER OPERATION.

4-11. In the voltmeter mode of operation, the input signal is applied to the impedance converter circuit through the 1:1 and 1000:1 attenuator. The 1:1 attenuation ratio is used on the 0.0003 to 0.3 VOLTS ranges, and the 1000:1 attenuation ratio is used in the 1 to 300 VOLTS ranges. With the FUNCTION switch in the VOLTMETER position, the output of the impedance converter bypasses the rejection amplifier and is applied to the metering circuit through the post-attenuator (METER RANGE switch). Metering circuit sensitivity is increased from 1 mV for full scale deflection to 300  $\mu$ V on the .0003V range, as it was in the distortion measuring operation. The function of the post-attenuator and metering circuit is the same for voltmeter operation as for the distortion measuring operation.

#### 4-12. DETAILED CIRCUIT DESCRIPTION.

#### 4-13. IMPEDANCE CONVERTER CIRCUIT. (Refer to Figure 7-2)

4-14. The input signal is applied to the impedance converter circuit through the 1:1 and 1000:1 attenuator S3R12 in voltmeter operation, and through the one megohm attenuator S2R1 through S2R6 in distortion operation. Capacitive dividers S2C1 through S2C10 in the attenuator keep the frequency response flat. The impedance converter is a low distortion, high input impedance amplifier circuit with gain independent of the source impedance placed at the INPUT terminals.

4-15. Instrument induced distortion of the signal being measured is minimized by keeping the input impedance and the gain of the impedance converter

linear. The input impedance is kept linear by use of local positive feedback from the source of A2Q1 to the gate of A2Q1 and to the protective diodes A2CR2 and A2CR3. Thus signals with a large source impedance can be measured accurately. Overall induced distortion is further minimized by a high open loop gain and 100% negative feedback. The high open loop gain is achieved by local positive feedback from the emitter of A2Q3 to the collector of A2Q2. Overall negative feedback from the emitter circuit of A2Q4 to the source of A2Q1 results in unity gain from the impedance converter.

4-16. The bias points of the transistors in the impedance converter are selected to minimize instrument induced distortion. A2Q1, an extremely low noise, high impedance field effect transistor, is the major component that makes linearity of the impedance converter independent of the signal source impedance.

#### 4-17. REJECTION AMPLIFIER CIRCUIT. (Refer to Figures 7-3 and 7-5)

4-18. The rejection amplifier circuit consists of the preamplifier (A3Q1 thru A3Q3), the Wien bridge resistive leg and auto control loop (A5Q1 thru A5Q9 with associated lamp and photocell), the reactive leg and auto control loop (A5Q10 thru A5Q18 with associated lamp and photocell), and the bridge amplifier (A3Q4 thru A3Q6).

#### 4-19. PREAMPLIFIER CIRCUIT.

4-20. The signal from the impedance converter is applied to the preamplifier, which is used during SET LEVEL and DISTORTION measuring operations. Negative feedback from the junction of A3R10 and A3R11 is applied to the junction of A3R2 and A3C2 to establish the operating point for A3Q1. Negative feedback from the emitter of A3Q3 is applied to the emitter of A3Q1 to stabilize the preamplifier. The preamplifier, like the impedance converter, is designed for high open loop gain and low closed loop gain to minimize instrument induced distortion.

#### 4-21. WIEN BRIDGE CIRCUIT.

4-22. In the distortion measuring operation the Wien bridge circuit is used as a rejection filter for the fundamental frequency of the input signal. With the FUNCTION selector, S1, in the DISTORTION position, the Wien bridge is connected as an interstage coupling network between the preamplifier circuit and the bridge amplifier circuit. The bridge is tuned to the fundamental frequency of the input signal by setting the FREQUENCY RANGE selector, S4, for the applicable frequency range, and tuning the capacitors C4A through C4D. The bridge circuit is balanced by adjusting the COARSE balance control, R4, and the FINE balance control, R5. In the AUTOMATIC MODE fine tuning and balancing are accomplished by photoelectric cells which are in the resistive and reactive legs of the Wien bridge. The error signals for driving the photocells are derived by detecting the bridge output using the input signal as a reference.

4-23. When the Wien bridge is not tuned exactly to the frequency to be nulled, a portion of the fundamental

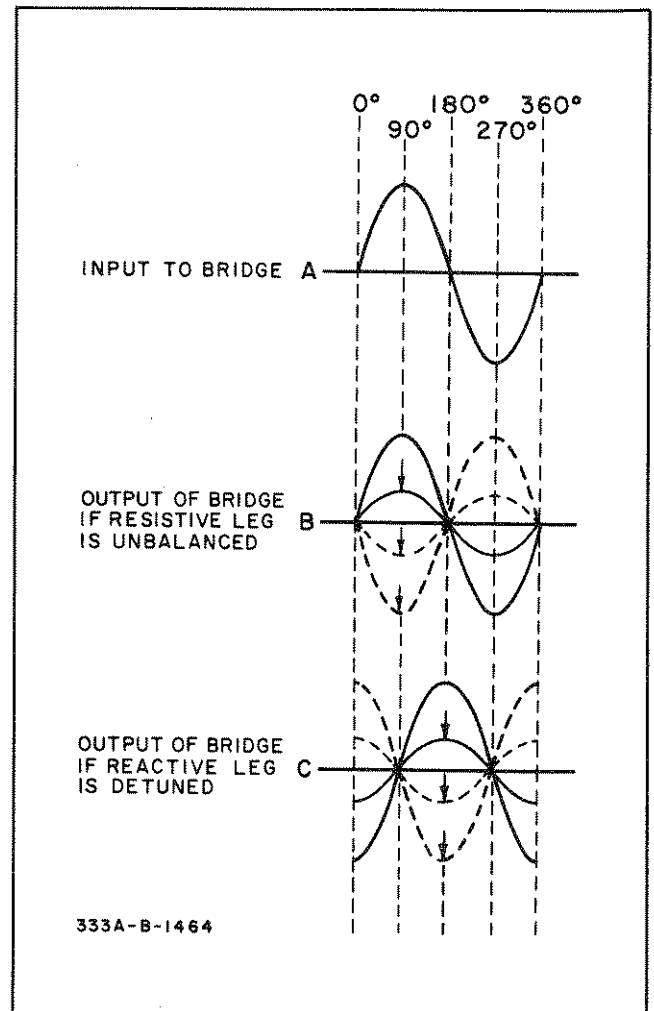

Figure 4-2. Bridge Waveforms

frequency will appear at the bridge output. The phase of this signal depends on which leg of the bridge is not tuned, or on the relative errors in tuning if neither is set correctly. The magnitude of the signal is proportional to the magnitude of the tuning error of either or both legs of the bridge.

4-24. Figure 4-2a shows a sinusoid input to the Wien bridge. If the resistive leg of the bridge is slightly unbalanced, the output of the bridge is very small, but has the waveform shown in Figure 4-2b and is in phase with the input. As the resistive leg is tuned, the signal approaches zero amplitude at null and then becomes larger, but 180° out of phase, if the null position is passed. When the resistive leg is correctly tuned and the reactive leg is tuned through null, a similar waveform is produced, Figure 4-2c. The only difference is that the reactive signal is 90° out of phase with the resistive signal.

4-25. When the bridge output is detected using the input signal as the reference, the error signals in phase or 180° out of phase with the reference develop a voltage that is used to vary the resistance in the resistive leg of the bridge, to tune it to the correct null position. Signals of the form in Figure 4-2c do not develop any voltage, as the resistive detector is insensitive to inputs differing from the reference by 90°.

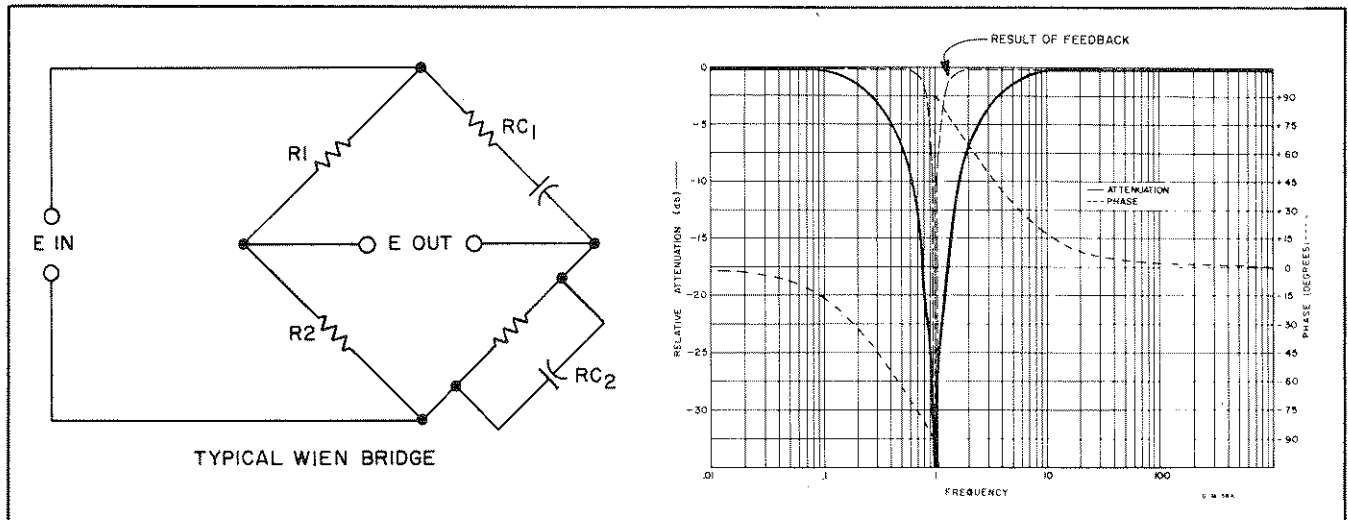

Figure 4-3. Wien Bridge Circuit and Rejection Characteristics

4-26. In an independent, but similar, control loop, the bridge input signal is shifted 90° and used as the reference signal for the detector. This detector develops control voltages to null the reactive leg of the bridge, but is insensitive to signals of the form in Figure 4-2b, which are caused by small tuning errors of the resistive branch.

4-27. The result is that the two control loops derive information from a common source and develop two independent control signals for nulling the two legs of the bridge. These control voltages are used to vary the brilliance of lamps, which in turn cause resistance changes in photocells that form part of the Wien bridge.

4-28. When the bridge circuit is tuned and balanced, the voltage and phase of the fundamental, which appears at junction of the series reactive leg (S4R1, 3, 5, 7, or 9 and C4A/B) and the shunt reactive leg (S4R11, 13, 15, 17, or 19, and C4C/D), is the same as at the midpoint of the resistive leg (A3R12 and A3R14). When these two voltages are equal and in phase, the fundamental frequency will not appear at the drain of the field effect transistor A3Q4. For frequencies other than the fundamental, the reactive leg of the Wien bridge offers various degrees of attenuation and phase shift which cause a voltage at the output points of the bridge. This difference voltage between the reactive leg and resistive leg is amplified by A3Q4, A3Q5, and A3Q6. Figure 4-3 illustrates a typical Wien bridge circuit and the rejection characteristics for it.

4-29. The Wien bridge circuit is designed to cover a continuous frequency range of over a decade for each position of the FREQUENCY RANGE selector S4. S4 provides coarse tuning of the reactive leg by changing the bridge circuit constants in five steps at 1 decade per step. For the automatic control loop, the reference voltage is taken from R6 at the input to the rejection amplifier and applied to the buffer amplifier A5Q7. The reference voltage is amplified and clipped by A5Q8 and A5Q9, and coupled to the detector A5Q4. The output of the metering circuit, which contains the fundamental frequency if either leg of the bridge is

untuned, is applied to the buffer amplifier A5Q1. It is amplified by A5Q2 and A5Q3 and coupled to the detector A5Q4.

4-30. Refer to Figure 4-4, partial schematic for detector operation. The discussion is applicable to both resistive and reactive detector circuits.

4-31. The signals from the error amplifier, (A5Q2 and A5Q3) will be equal and of opposite phase, and will cancel out each other when the detector, A5Q4, is off. However, when the positive half of the reference square wave gates A5Q4 on, the signal from the collector of A5Q3 will be shorted to ground. Thus the signal from the collector of A5Q2 will be coupled through the filter network to the base of A5Q5. If the signal from A5Q2 is in phase with the reference, the positive half of the signal will be passed, and if it is out of phase, the negative half will be passed.

4-32. The normal working voltage at A5TP3 is between 0 and -1 volt. The dc output of the filter network causes the voltage at A5TP3 to go in a positive direction (toward zero) for in phase error signals, and in a negative direction (toward -1 V) for out of phase error signals. The change in base voltage is then amplified by A5Q5 and lamp driver A5Q6. This will change the brilliance of lamp A6DS1, which will vary the resistance of A6V1 in the direction necessary to balance the resistive leg of the bridge.

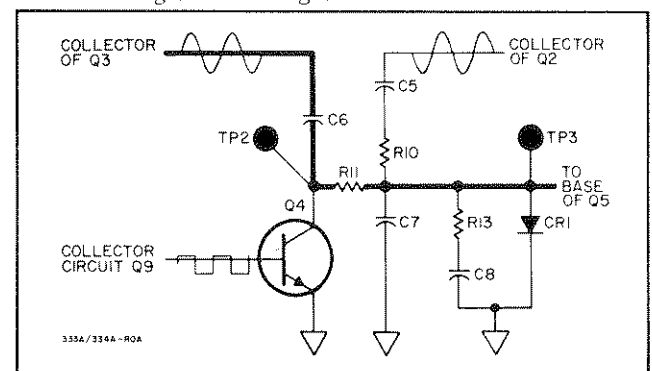

Figure 4-4. Auto Control Loop Detector

4-33. Refer to Figure 4-5 for the phase relationship of the bridge error signal and reference voltage at the base of A5Q4. The shaded portions of the error signals (b and c) indicate that part of the error signal which contributes to the dc lamp control voltage. As indicated in d, any error signal that is 90° out of phase with the reference does not affect the dc lamp control voltage, because equal amounts of the positive and negative portions are passed.

4-34. The operation of the reactive branch control loop is similar to that of the resistive branch. The

phase delay circuit, A5Q15, A5Q16, S4AF and S4C1 through S4C5, shifts the reference voltage 90°, as shown in Figure 4-5f. This makes the detector A5Q12 sensitive to components of the bridge error signal that are 90° out of phase (g and h). The output of the lamp driver, A5Q14, controls the brilliance of A6DS2, which varies the resistance of A6V2 through A6V5 to tune the branches of the reactive leg. Deck AR of the FREQUENCY RANGE switch, S4, switches A5R56 in parallel with A5R55 on the top three frequency ranges. A6DS2 will become brighter, and lower the resistance of A6V2 through A6V5, making variation

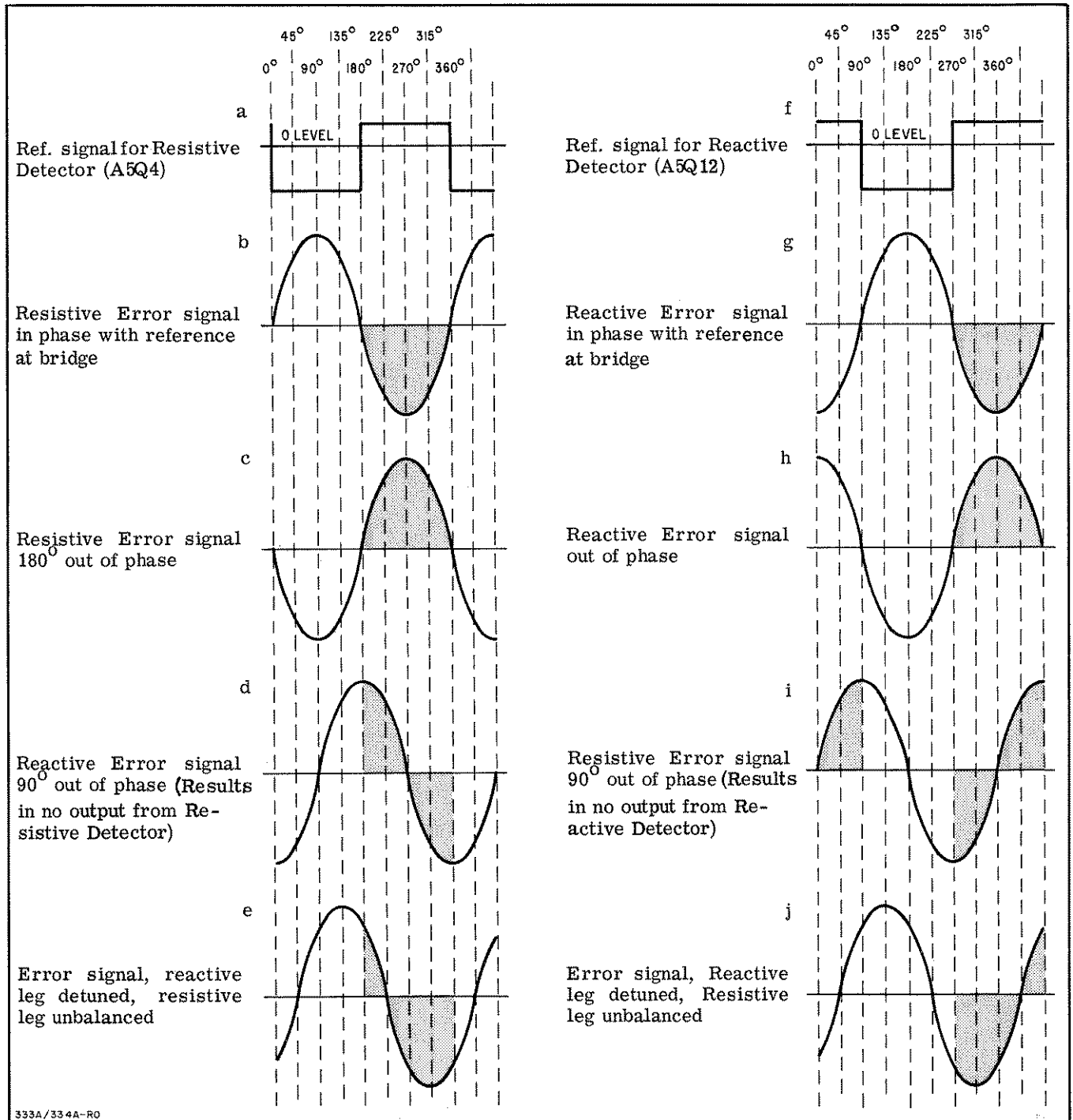

Figure 4-5. Reference and Error Phase Relationship



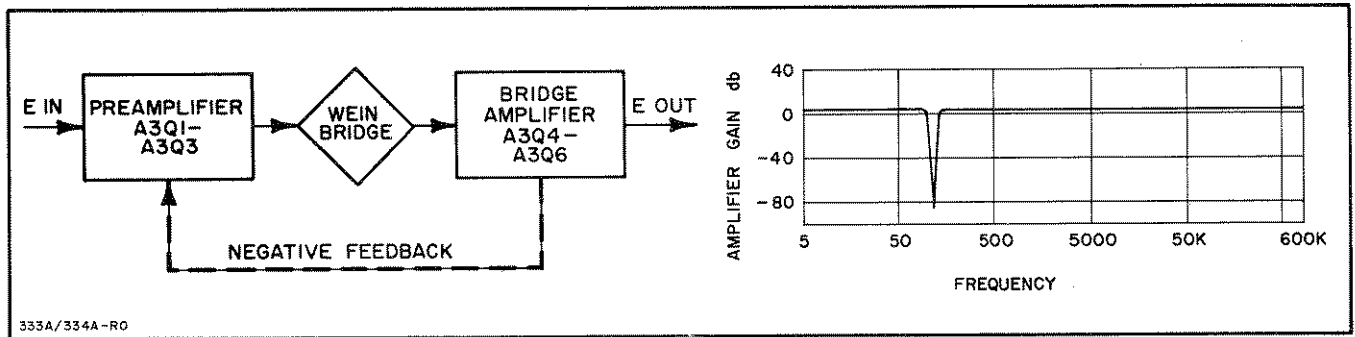

Figure 4-6. Rejection Amplifier Block Diagram and Typical Frequency Rejection Characteristic

in resistance less than on the two lower ranges. However, less variation in resistance is needed to tune the leg, because the impedance in the reactive leg becomes progressively less as the higher frequency ranges are selected.

4-35. Any error signal that is not an integral multiple of  $90^\circ$  is the result of the reactive leg of the bridge being detuned, and the resistive leg being unbalanced. For example, an error signal that is  $45^\circ$  out of phase (Figure 4-5e and j) will result in outputs from both resistive and reactive detectors to tune the bridge and reject the fundamental.

4-36. When the FUNCTION selector is set to the VOLTMETER or SET LEVEL position, the junction of the series and shunt reactive branches of the Wien bridge is connected to circuit ground through A3R19 by S1BF which disables the frequency rejection characteristic of the bridge circuit. With the bridge circuit disabled, the rejection amplifier circuit provides one dB of gain for the fundamental frequency and the harmonics. In the SET LEVEL operation, this signal is used to establish the SET LEVEL reference.

#### 4-37. BRIDGE AMPLIFIER CIRCUIT.

4-38. The bridge amplifier circuit consists of three stages of amplification, A3Q4 through A3Q6. The first stage of amplification, A3Q4, is a field effect transistor which amplifies the difference signal between the gate and the source. The field effect transistor is selected for minimum noise performance with the high impedances of the Wien bridge circuit. The signal from the drain is applied to the two stage feedback amplifier A3Q5 and A3Q6. The output of A3Q6 is coupled to the meter circuit by the post attenuator S3R1 through S3R11. Negative feedback from the output of the bridge amplifier is applied to the preamplifier circuit to narrow the frequency rejection characteristic. It can be noted from the rejection characteristic (refer to Figure 4-3) for the bridge that the rejection of harmonic voltages is not constant. Typically the second harmonic is attenuated several dB more than the third harmonic and the third more than the fourth. The result of the negative feedback is illustrated by the rejection characteristic shown in dashed lines on the attenuation and phase characteristic of Figure 4-3. Figure 4-6 shows a simplified block diagram of the rejection amplifier with the typical frequency-rejection characteristic.

Refer to Figure 4-7, Bandwidth Versus Null Depth for further detail on the rejection characteristic.

#### 4-39. HIGH PASS FILTER. (Refer to Figure 7-3).

4-40. The HIGH PASS FILTER is normally used when the fundamental of the input signal is greater than 1 kHz. In the voltmeter mode of operation, the filter is not used. In SET LEVEL and DISTORTION functions the filter presents >40 dB attenuation to 50 or 60 Hz hum components, but offers no attenuation to frequencies over 1 kHz. The filter assembly, A7, consists of A7C1, A7C2, and A7L1. The filter can be inserted or bypassed by the HIGH PASS FILTER switch, S9.

#### 4-41. METER AMPLIFIER. (Refer to Figure 7-4)

4-42. The meter amplifier consists of the post attenuator, the meter amplifier circuit, and the meter rectifier circuit.

#### 4-43. POST ATTENUATOR.

4-44. The post attenuator, S3R1 through S3R11, is a resistive network which attenuates the input signal in 10 dB steps. The attenuator is used in conjunction with either the input sensitivity attenuator or the 1000:1 attenuator to limit the signal level to the meter amplifier to 1 mV for full scale deflection on all ranges from 1 mV to 300 V full scale. The meter circuit sensitivity is increased to  $300 \mu\text{V}$  for full scale deflection on the .0003V range by switching resistors A2R29 and A2R30 into the calibration network. Resistor A2R41 and capacitor A2C29 are also switched into the calibration network on the .0003V range to extend the passband of the amplifier.

#### 4-45. METER AMPLIFIER CIRCUIT.

4-46. The meter amplifier circuit consists of a five stage amplifier circuit, A2Q5 through A2Q9, which develops the current for full scale meter deflection. Negative dc feedback from the emitter circuit of A2Q8 is applied to the base of A2Q5 to stabilize the dc operating point of the meter amplifier circuit and to minimize the tendency for dc drift due to ambient temperature changes. A2R51 and A2CR8 are electrically in the circuit only when the meter amplifier is overloaded. When the voltage on the emitter of A2Q9

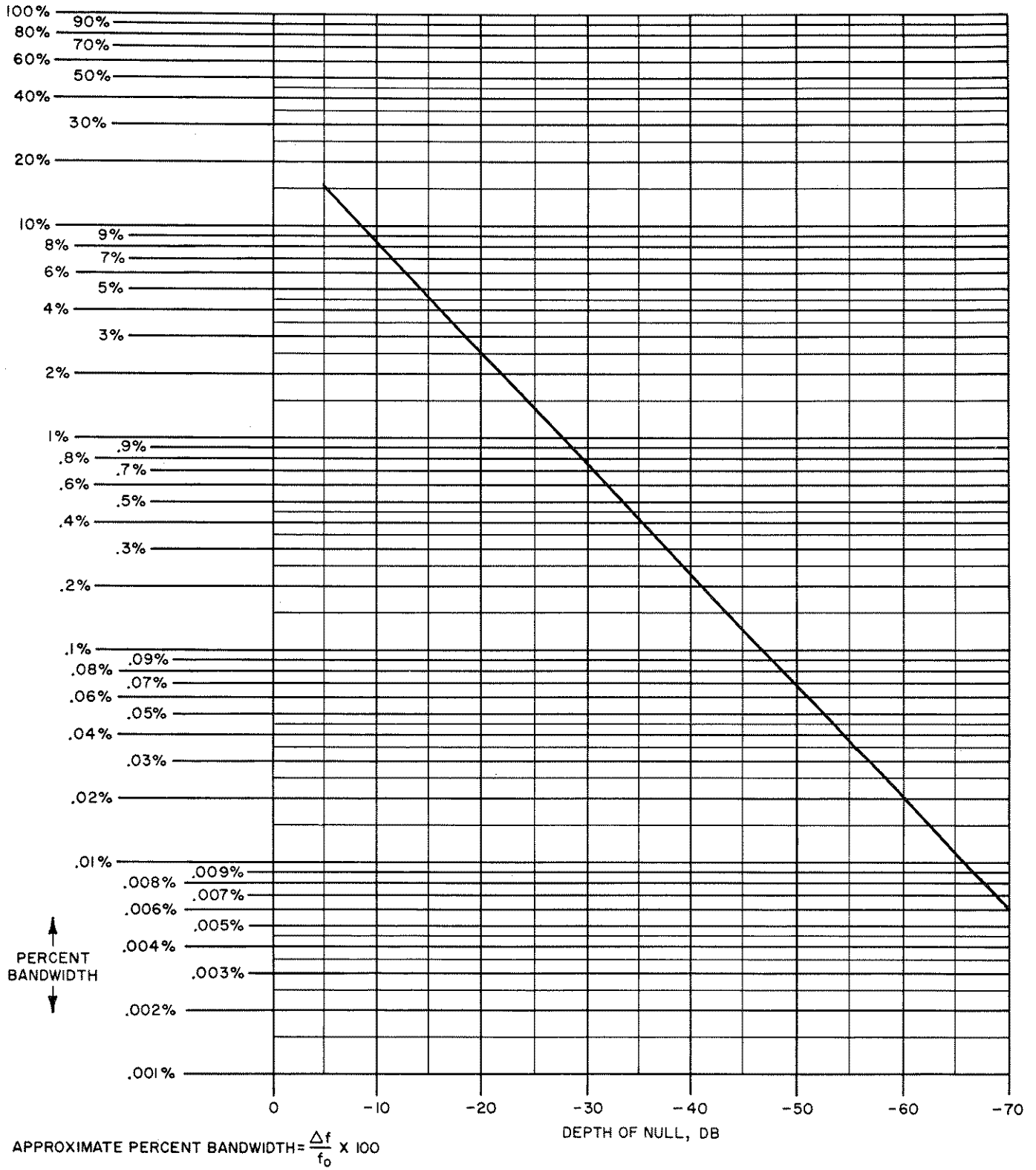

Figure 4-7. Bandwidth Versus Null Depth

becomes abnormally large during an overload, A2CR8 breaks down and provides a lower resistance charging path for A2C15, which reduces the transient recovery time of the meter amplifier. Negative ac feedback is applied from the collector circuit of A2Q9 to the emitter circuit of A2Q5. This feedback is used to ensure flat frequency response, to improve linearity, and to reduce the effect of variation of transistor parameters with environmental changes. In this manner, the calibration of the instrument is made dependent on high quality passive components.

4-47. METER RECTIFIER CIRCUIT.

4-48. The meter rectifier is connected in a bridge type configuration with a diode in each upper branch and a dc milliammeter connected across the midpoints of the bridge. The simplified meter rectifier is illustrated in Figure 4-8. The generator represented by A2Q5 through A2Q9 with the internal impedance  $R_0$  provides the meter, M1, with current for full scale deflection and develops a voltage across the calibration network, which closes the ac feedback loop. Capacitors A2C27 and A2C28 are used as coupling capacitors for the ac feedback loop, output signal to the OUTPUT connector, and the bridge error signal to the input of the automatic fine tuning loops. The mechanical inertia of the meter and A2C26 prevents the meter from responding to individual current pulses. Therefore, the meter indication corresponds to the average value of the current pulses rather than the peak value. The meter is calibrated to indicate the rms value of a sine wave. Resistor A2R45 impresses a fixed bias across diodes A2CR6 and A2CR7 (biasing them close to the barrier voltage) to make the meter amplifier response linear to large variations

in signal amplitude. The linearity of this type of circuit is also increased by including the meter circuit in the overall feedback loop.

4-49. POWER SUPPLY CIRCUIT.  
(Refer to Figure 7-6)

4-50. The power supply circuit consists of a +25 volt series regulated supply and a -25 volt series regulated supply which is the reference supply for the +25 volt supply.

4-51. The -25 volt regulated supply is of the conventional series regulator type. The amplifier A1Q5 is used to increase the loop gain of the circuit, thus improving voltage regulation. The positive feedback applied to the junction of A1R11 and A1R12 is used to further improve the line frequency suppression of the circuit.

4-52. The +25 volt regulated supply is of the conventional series regulator type and operates the same as the -25 volt regulated supply.

4-53. RF DETECTOR CIRCUIT. (334A only)  
(Refer to Figure 7-2)

4-54. The RF detector circuit consists of a rectifier, A4CR1, and filter circuit. The RF signal is applied to the circuit through the RF INPUT connector on the rear panel. The rectifier diode A4CR1 recovers the modulating signal from the RF carrier and the filter circuit removes any RF components before the signal is applied to the impedance converter circuit through the NORM-RF DET switch, S7.

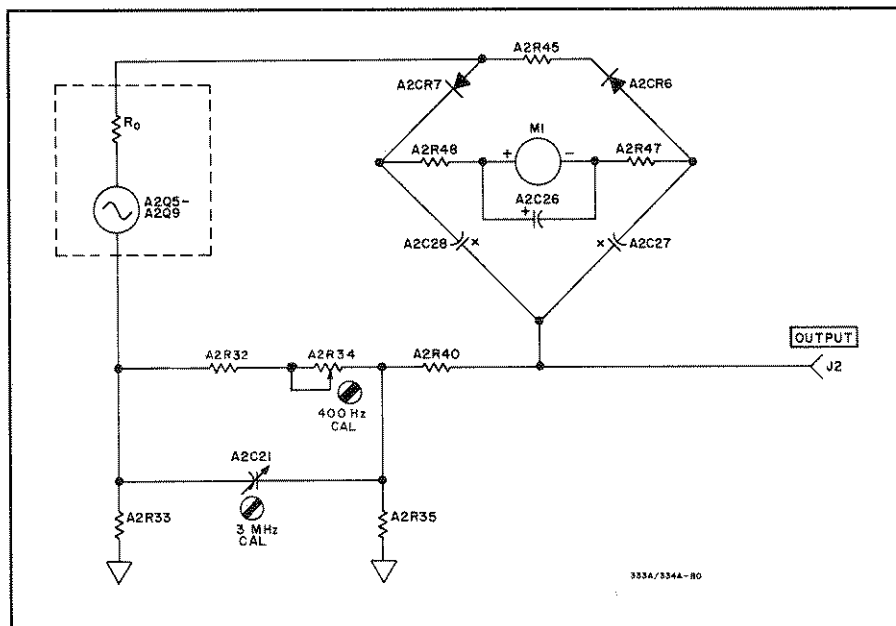

Figure 4-8. Simplified Metering Circuit